

SPECIFICATION SHEET

PRODUCT # : T-LT75 (Multi-tap)

- Transformers
- Landscape Series



Transformer Specifications:

Enclosure: Top grade 304 stainless steel, NEMA 3R

Electrical Characteristics:

Wattage: 75W

Primary Voltage: 120 Volts

Secondary Voltage: 12, and 15 volts

Secondary Protection: High performance magnetic circuit breaker. May also be used as on/off rocker switch.

Terminal Block: Extra large terminal block for multiple low voltage cable connections.

Cable cord: 6-foot, heavy gauge, grounded and water resistant power cord with molded plug.

Core: Fully encapsulated TOROID core

Timers & Photocell: Built in mechanical timer included. Photocell (T-TR-FIP) on enclosure is available separately.

Wire Rating: Internal wires are rated at 125°C (257°F)

Certification: Class 1 Transformer. ETL listed to U.S. safety standards for landscape lighting transformers (UL1838). Pool and spa ready, suitable for use with submersible fixtures.

Warranty: Limited lifetime on coil and enclosure. One year on mechanical timer and photocell.

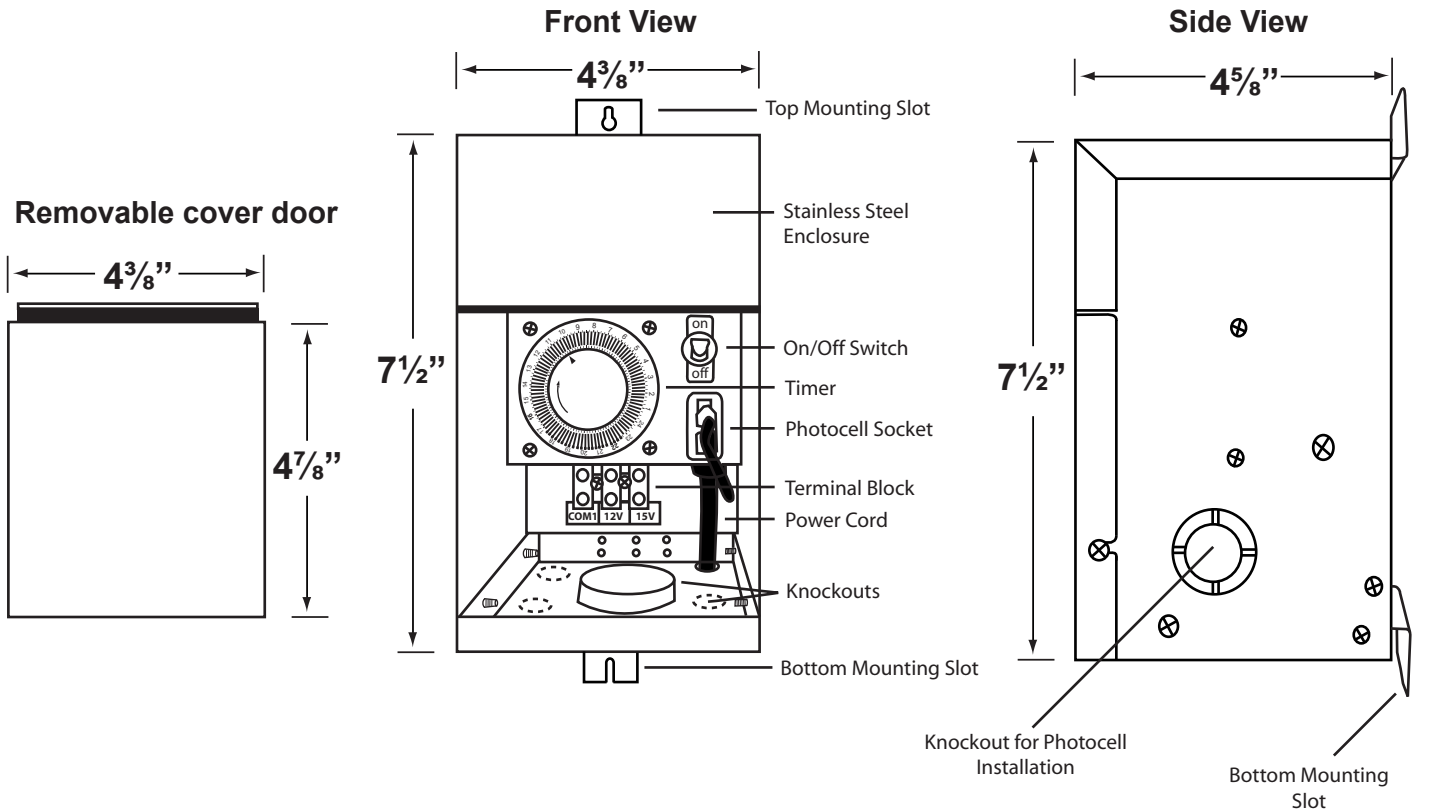

PHOTOCELL

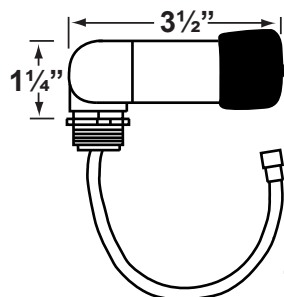

• Corona Lighting reserves the right to make any change and/or improvement to the design and construction of this fixture without further notification.

SPECIFICATION SHEET

PRODUCT # : T-LT75 (Multi-tap)



FEATURES:

- Easy removable stainless steel hinged cover door, allowing great access during installation.
- Moisture resistant gasket cover door.
- Over-sized wiring terminal block for easy multiple low voltage cable connections.
- Removable bottom plate with prepunched knockouts 3X $\frac{1}{2}$ " or 3X $\frac{3}{4}$ " conduits and 1X1 $\frac{3}{4}$ " cable feeder for easy entrance of multiple low voltage cables during installation.
- Mounting slots on top and bottom for quick mounting without templates.
- 6-foot, heavy gauge, grounded and water resistant power cord with molded plug. The power cord gets through an open hatch, on the right side of the enclosure interior.
- Compatible with low-voltage (12V) magnetic dimmer switches and controls.
- Built-in mechanical timer included.
- Optional photocell is available for use with timer or stand alone. Photocell is attached to enclosure, easy knockout. (Supplied Separately)
- ETL listed to U.S. safety standards for landscape lighting transformers (UL1838), Pool and Spa ready, suitable for use with submersible fixtures.
- Dimensions: 4 $\frac{3}{8}$ "W x 7 $\frac{1}{2}$ "H x 4 $\frac{5}{8}$ "D
- Gross Weight: 9LBS (4.08kg)
- Application: LED lighting systems. Landscape lighting systems.
- Warranty: The transformer must be installed in accordance with the national electric code (NEC) and local ordinances. Failure to do so will void the warranty and may result in serious injury and/or damage to the transformer.

WARNINGS:

- Risk of electric shock: Install the transformer at least 5 feet from pool or spa and at least 10 feet from a fountain. If the transformer is installed within 10 feet of a pool or spa connect it to a GFCI protected circuit.
- The transformer must be connected to a GFCI receptacle with cover, marked "WET LOCATION" while it is in use.
- The transformer is for use ONLY on a circuit that is protected by a class "A" ground fault circuit interrupter (GFCI).
- For use ONLY with landscape lighting system. For "OUTDOOR USE ONLY", not for use inside dwelling units.
- Do not connect two or more transformers in parallel. Do not use extension cord with transformers.

POOL & SPA RATED:

- According to the national electrical code (NEC), all lighting fixtures within 10 feet of water falls, ponds, fountains and other type of water features, must be powered by a Pool & Spa rated transformer.
- This T-TR-150 transformer carries ETL approved to UL1838, rated for pool & spa. This part of the code is also applied to transformer that are used with submersible lighting fixtures.
- Now you can use this transformer with confidence, knowing that it will meet the requirements of electrical inspectors that are calling this rating.

SPECIFICATION SHEET

PRODUCT # : T-LT75 (Multi-tap)



TRANSFORMER SIZING:

- Low voltage lighting systems require the use of a transformer to reduce the standard 120 volt power from ordinary household electricity to 12, and 15 volt needed to power low voltage fixtures.
- The total wattage of all fixtures connected to one transformer must not exceed the wattage capacity of the transformer.
- To determine the size of transformer needed in a low voltage lighting system, add up the wattage of all fixtures in system and then add 10% for low voltage cable and fixtures connections.

SIZE OF TRANSFORMER= TOTAL WATTAGES OF FIXTURES x 1.1

- Select a transformer that matches as close as possible to calculation shown above.
Example: you have 7 fixtures, each 35 watt. You need a 300 watt transformer (7x35=245 plus 10%= 269.5)
- If the total load of fixtures is too great, either divide the total load between 2 transformers or use a more powerful transformer.
- Select a transformer with 20% higher capacity than total wattage of all fixtures in system, that allow you to add more fixtures later.

INSTALLATION OF TRANSFORMER:

- Remove the hinge type cover door easily, by pulling up on enclosure.
- Pull the 6 foot power cord plug out of the enclosure through an open hatch, on the right side of the enclosure's interior.
- Choose a flat and solid wall to mount the transformer. The bottom of the enclosure should be at least 12" above the finish floor with wire terminal block facing down. The location of the transformer should be less than 6 feet from 120 volt supply circuit, protected by a class "A" GFCI.
- Align the transformer horizontally and parallel to finish floor. Mark the top and bottom mounting brackets' keyhole slots and predrill holes on marks of keyhole slots. Use anchor bolts supplied and insert inside the holes. Secure the transformers keyhole slots on top mounting bracket and bottom by using supplied screws into the anchor bolts.

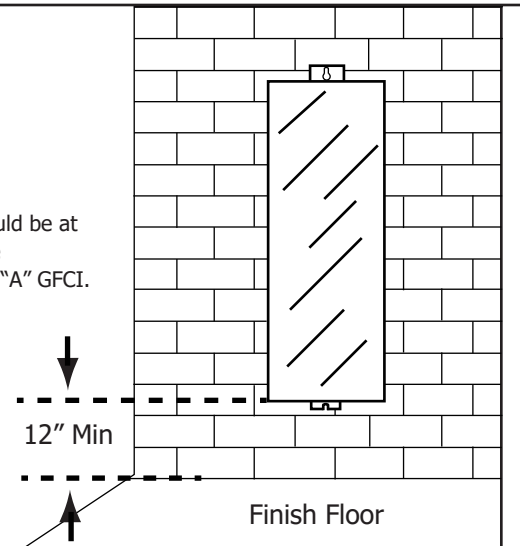

CONNECTION OF MAIN CABLE TO TRANSFORMER:

- Remove the bottom plate from transformer.
- Use a screwdriver and loosen the COM1 tap and proper low voltage taps (12V or 15V) on terminal block in order to connect the main cable.
- Run the main cable, through one of the knockouts of bottom plate. Separate the wires of main cable and strip both for about 1".
- Connect one wire to COM1 tap and the other to proper low voltage tap. Make sure both are fully inserted into terminal block.
- Secure both wires to both taps by tightening the COM1 tap and low voltage taps with a screwdriver.
- If photocell is not used, plug in photocell socket with jumper supplied with transformer.
- Replace the bottom plate and cover door on the transformer.

SPECIFICATION SHEET

PRODUCT # : T-LT75 (Multi-tap)



CHECK VOLTAGE AT EACH FIXTURE:

Make sure the secondary voltage applied on each fixture is within input voltage range of that fixture. Halogen and LED lamps have an input voltage of 12 volt. If the input tap is 12 volt, the input voltage to the fixture should be between 11 and 12 volts. If the voltage at the fixture socket is more than 12 volt, the light output of fixture will be higher and the average lifetime will be lower. If the voltage at fixture socket is less than 11 volt, the light output of fixture will be lower and the average lifetime might be higher. Many LED lamps have a range of input voltage. Make sure the input voltage supplied to each LED lamp is within the range of input voltage of LED lamp.

- Connect the cord of transformer into a covered 120 volt GFCI receptacle.
- Turn the inside circuit breaker "ON" to provide secondary voltage to fixtures.
- Check the voltage of each fixture by using a voltage meter.
- Measure the voltage of each fixture, and make sure it is within the voltage range of each regular lamp or LED lamp.
- If the measured voltage is not within voltage range of regular lamps, or LED lamps adjust the voltage to an acceptable amount by moving the wire of cable to higher or lower voltage tap.

CHECK OUTPUT CURRENTS:

After checking the voltage on each fixture use a clamp-on meter and measure the output current on the low voltage cable of each circuit. Make sure the output current of each circuit is below the maximum rated amp.

Size of Circuit	50 Watts	100 Watts	150 Watts	200 Watts	300 Watts
Amp Rating	4.16 A	8.33 A	12.5 A	16.66 A	25 A

VOLTAGE DROP AND SIZING THE MAIN CABLE:

Voltage drop has an important impact on Low voltage lighting systems. Voltage drop occurs along the length of cable and lamps at the end of run dimmer than beginning. Voltage drop is a function of a cable length, cable size, and total fixtures wattage. Voltage drop can be minimized in several different ways:

- Use heavier gauge cable
- Shorten cable length or runs
- Reduce wattage of each fixture
- Use multiple transformers
- Reduce total number of fixtures on a run.

Cable is measured by gauge. The lower gauge, the thicker the cable and more current it carries. Cable is available in 3 popular sizes of 12-2, 10-2, and 8-2. Refer to cable length guide in below to estimate the maximum allowable cable length.

LOW VOLTAGE CABLE LENGTH GUIDE:

Cable Size	Cable Constant	MAXIMUM CABLE LENGTH PER TOTAL FIXTURE WATTS					
		50W	100W	150W	200W	250W	300W
12-2	7500	300'	150'	100'	75'	60'	-----
10-2	11920	475'	240'	160'	120'	100'	80'
8-2	18960	750'	380'	250'	190'	150'	125'

CABLE LENGTH FORMULA: MAX. CABLE LENGTH = $\frac{\text{CABLE SIZE CONSTANT}}{\text{TOTAL FIXTURE WATTS}} \times 2$

TIP: Expect a voltage drop of greater than 2 volts when cable length is longer than recommended. Use the above chart or formula to calculate max. cable length.

SPECIFICATION SHEET



12 VOLT CABLE LAYOUT OPTIONS

TIP: Connect all lamps in parallel. Connect one side to "COM" and other side to "12V" terminal

LOOP INSTALLATION:

Fixtures are arranged in a loop, reducing voltage drop

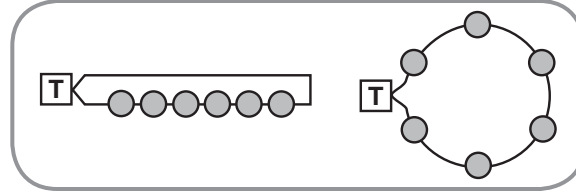

SPLIT LOAD INSTALLATION:

Fixtures run in two or more directions from transformer. Locating the transformer in the center of run reduces the effects of voltage drop.

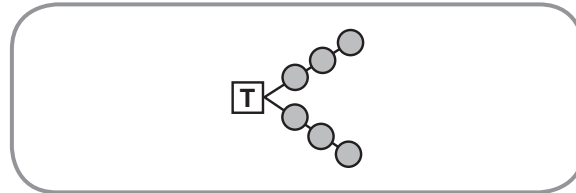

STRAIGHT RUN INSTALLATION:

Fixtures run in sequence directly from transformer.

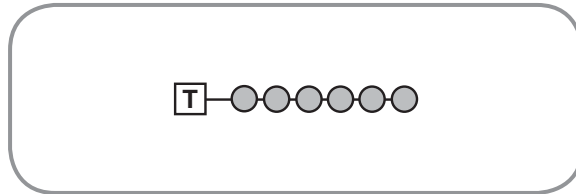

"T" INSTALLATION:

Allows more equal distribution of power to center of the run, or to a run some distance away. Main cable must be heavier gauge (10-2 or (8-2).

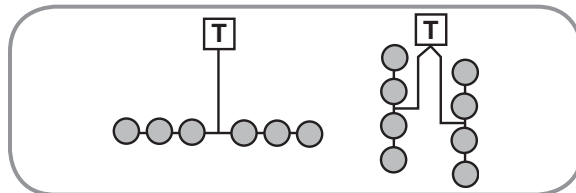

TROUBLE SHOOTING CHECKLIST

Solutions to most Common Problems

ENTIRE SYSTEM WILL NOT OPERATE

1. Check 120V outlet to ensure power is on
2. Check or re-set circuit breaker on transformer.
3. Check cable connection at transformer.
4. Check transformer by disconnecting cable from output terminals. By-pass timer and/or photocell.

FIXTURE HAS MOISTURE BUILT-UP INSIDE

1. Check shrouds and lens rings installed properly.
2. Check for missing or torn gaskets.
3. Check drainage holes for blockage.

CIRCUIT BREAKER ON TRANSFORMER TRIPS

1. Check cable for any short circuit.
2. Check connection of cable at transformer
3. Recalculator total wattage to ensure not exceeding wattage of transformer or wire length of each run.

FIXTURE ON, BUT DIMS

1. Check connection point at power cable.
2. Recalculate total watts and max. cable length to insure voltage drop does not exceed 2 volts.

FIXTURE WILL NOT LIGHT

1. Check lamp for broken filament.
2. Check lamp for proper fit in socket
3. Check fixture connection at power cable..