

# SPECIFICATION SHEET

## PRODUCT # : CL-541C-RC

•Directional Lights

•Solid Copper

### Fixture Specifications:

**Housing & Shroud:** Corrosion Resistant Solid Copper.

**Finish:** RC- Raw Copper. Will age gradually over time.

**Lens:** Clear and heat resistant convex glass.

**Socket:** Top grade loose ceramic bi-pin socket, spring loaded design.

**Lamp:** 12V, MR-16, 35W max.  
 Available in LED (3.5W & 5W) or without lamp.  
 See the Lamp Guide below for more information.

**Wiring:** Fixture is prewired with a 3-ft 18-2 SPT2-W direct burial cord. Wire connector sold separately.  
 Universal connector (CX-839) and silicone filled wire nut (CX-854) are available from Corona Lighting.

**Gasket:** Silicone double gasketed for water tight sealing

**Knuckle:** Adjustable cast brass knuckle with thumb screw and 1/2" NPT threaded male hub on bottom.

**Mounting Spike:** Standard injection molded spike with 1/2" NPT threaded female hub.

**Electrical Notes:** A remote 12V transformer is required. Options are available from Corona Lighting.  
 Voltage range for LED lamps are 9V-17V.  
 Proper grease/lubricant is suggested on threaded parts during installation process.

**Warranty:** Limited lifetime warranty on fixture housing against manufacturer's defects.



3.5W and 5W

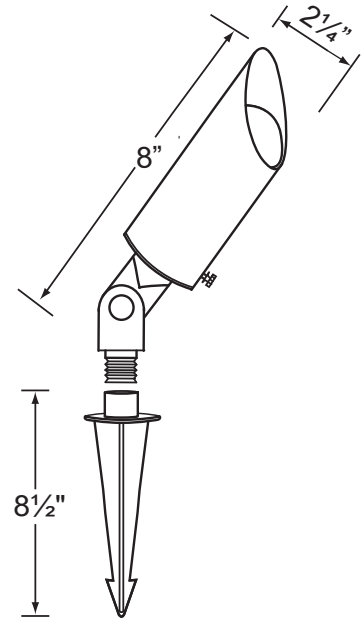

### AVAILABLE LED LAMPS (Corona LED lamps have a five (5) year limited warranty against manufacturer's defects)

LAMP NUMBER	WATTS	BEAM		COLOR & TEMP.	RATED HOURS	HALOGEN EQUIVALENT
		SPREAD	LUMEN			
L-ED16-3W-SP	3.5	15° Spot	270	2700K	50,000	25 Watt
L-ED16-3W-FL	3.5	45° Flood	270	2700K	50,000	25 Watt
L-ED16-3W-WF	3.5	60° Wide Flood	270	2700K	50,000	25 Watt
L-ED16-5W-SP	5	15° Spot	350	2700K	50,000	40 Watt
L-ED16-5W-FL	5	45° Flood	350	2700K	50,000	40 Watt
L-ED16-5W-WF	5	60° Wide Flood	350	2700K	50,000	40 Watt
L-ED16-COB5W-SP	5	15° Spot	450	2700K	50,000	50 Watt
L-ED16-COB5W-FL	5	38° Flood	450	2700K	50,000	50 Watt
L-ED16-COB5W-WF	5	60° Wide Flood	450	2700K	50,000	50 Watt
L-ED16-COB5W-SP3K	5	15° Spot	470	3000K	50,000	50 Watt
L-ED16-COB5W-FL3K	5	38° Flood	470	3000K	50,000	50 Watt
L-ED16-COB5W-WF3K	5	60° Wide Flood	470	3000K	50,000	50 Watt

Single color MR-16 LED available in AMBER, BLUE, GREEN, PURPLE, RED and VIOLET

### JOB INFORMATION

TYPE: \_\_\_\_\_ DATE: \_\_\_\_\_  
 JOB NAME & ADDRESS: \_\_\_\_\_  
 PRODUCT #: \_\_\_\_\_  
 TOTAL QUANTITY: \_\_\_\_\_  
 LAMP TYPE & WATTAGE: \_\_\_\_\_  
 TRANSFORMER: \_\_\_\_\_  
 CONTRACTOR: \_\_\_\_\_  
 SPECIFIER: \_\_\_\_\_

• When ordering LED lamp with a fixture your part number should follow the format below:

• CL - product # - lamp - wattage - lamp angle

CL - 541C-RC - L-ED16 - 5W - FL

Example: CL-541C-RC-L-ED16-5W-FL

• Corona Lighting reserves the right to make any change and/or improvement to the design and construction of this fixture without further notification.

# ACCESSORIES SHEET

## PRODUCT # : CL-541C-RC

•Directional Lights

•Solid Copper

### Mounting Pedestals

- CX-601-BK 1" PVC Mounting Pedestal, 1/2" NPT, **Black**
- CX-601-VG 1" PVC Mounting Pedestal, 1/2" NPT, **Verde Green**
- CX-603-BK 3" PVC Mounting Pedestal, 1/2" NPT Female Brass Hub on top, **Black**
- CX-603-VG 3" PVC Mounting Pedestal, 1/2" NPT Female Brass Hub on top, **Verde Green**

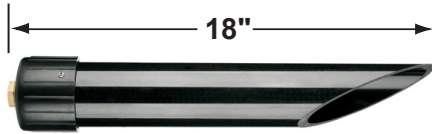

**CX-603-BK**

- CX-604-BK 1" PVC Adjustable Mounting Pedestal, 1/2" NPT, **Black**
- CX-621-BK 1" PVC Cap, 1/2" NPT, **Black**
- CX-621-VG 1" PVC Cap, 1/2" NPT, **Verde Green**
- CX-622-BK 2" PVC Cap, 1/2" NPT, **Black**
- CX-622-VG 2" PVC Cap, 1/2" NPT, **Verde Green**
- CX-624-BK 3" PVC Cap, 1/2" NPT Female Brass Hub, **Black**
- CX-624-VG 3" PVC Cap, 1/2" NPT Female Brass Hub, **Verde Green**

### Ground Spikes

- CX-642-BK 8.5" ABS Spike, 1/2" NPT, **Black**
- CX-642-BZ 8.5" ABS Spike, 1/2" NPT, **Bronze**
- CX-643-BZ 8.5" ABS Spike, 1/2" NPT, **Bronze**

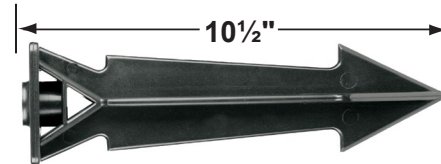

**CX-647-BK**

- CX-646-BK 8" ABS Spike, 1/2" NPT, **Black**
- CX-646-BR 8" ABS Spike, 1/2" NPT, **Natural Brass**
- CX-646-SS 8" ABS Spike, 1/2" NPT, **Stainless Steel**
- CX-647-BK 10.5" Heavy Duty ABS Spike, 1/2" NPT, **Black**

### Mounting Risers

- CX-682C-RC 6" Copper Riser, 1/2" NPT Male/Female, **Raw Copper**
- CX-683C-RC 12" Copper Riser, 1/2" NPT Male/Female, **Raw Copper**
- CX-684C-RC 18" Copper Riser, 1/2" NPT Male/Female, **Raw Copper**
- CX-685C-RC 24" Copper Riser, 1/2" NPT Male/Female, **Raw Copper**

### Mounting Canopies

- CX-705B-BR Brass Flat Canopy, 1/2" NPT, **Natural Brass**
- CX-709B-BR Brass Raised Canopy, 1/2" NPT, **Natural Brass**
- CX-719B-BR Brass Tree Mounting Bracket, 1/2" NPT, **Natural Brass**
- CX-720-BR Brass Tree mount Canopy with 9" Rubber Strap stretches to 14, **Natural Brass**
- CX-721-BR Brass Tree mount Canopy with 15" Rubber Strap stretches to 22", **Natural Brass**
- CX-722-BR Brass Tree mount Canopy with 22" Rubber Strap stretches to 33", **Natural Brass**
- CX-723-BR Brass Tree mount Canopy with 31" Rubber Strap stretches to 45", **Natural Brass**

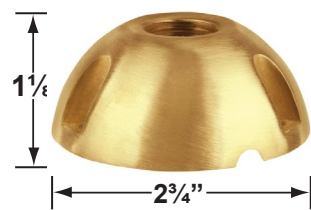
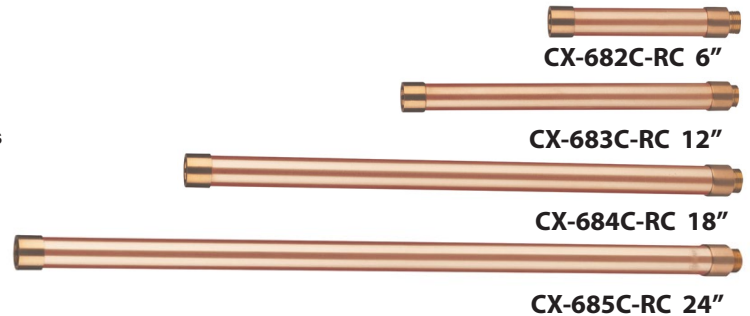

**CX-709B-BR**



**CX-705B-BR**

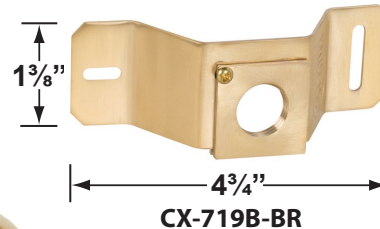

**CX-719B-BR**



**CX-722-BR**

# ACCESSORIES SHEET

## PRODUCT # : CL-541C-RC

•Directional Lights

•Solid Copper

### Mounting Posts For Path Light Applications

- CX-678C-RC 24" Copper Single Head Post, **Raw Copper**
- CX-679C-RC 24" Copper Double Head Post, **Raw Copper**
- CX-690C-RC 18" Copper Single Head Post, **Raw Copper**
- CX-693C-RC 18" Copper Double Head Post, **Raw Copper**

### Cable Connectors

- CX-854 Direct Burial Silicone Filled Wire Nut, **Tan**
- CX-858 Speedy Cable Connector, Supply Cable up to 10-2, **Black**
- CX-839 Universal cable connector, Supply cable up to 8-2, one/Pack **Black**

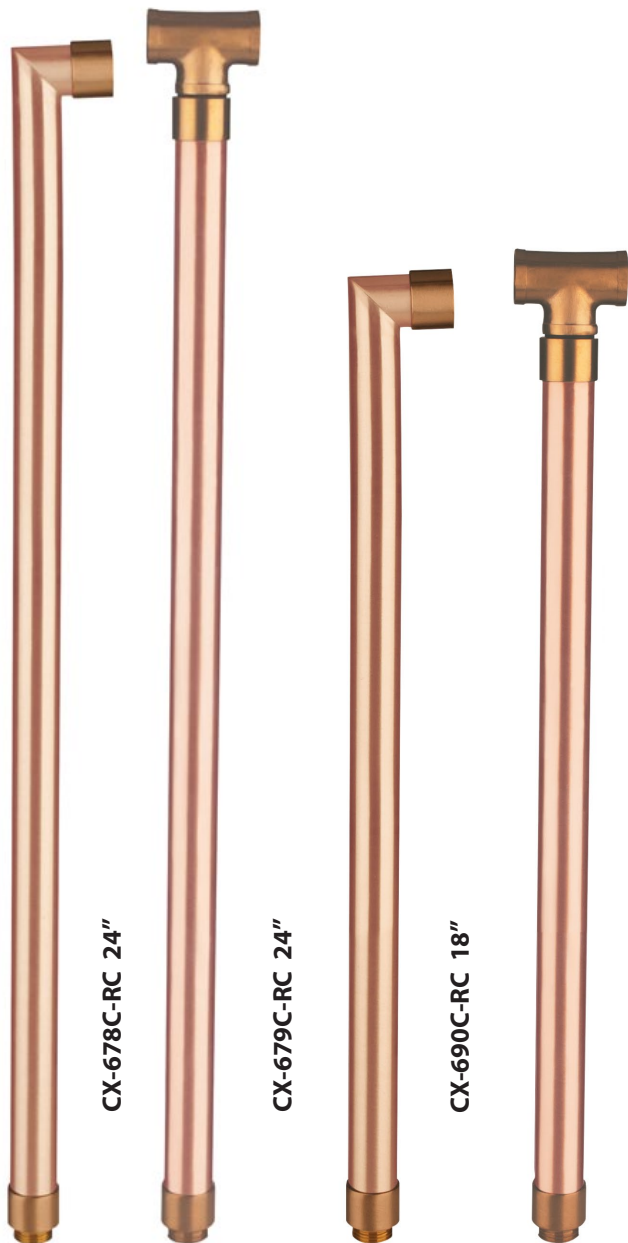

### Special Lenses & Honeycomb Louvers

- CX-238 MR-16 Snap-on holder, **Silver Plated**
- CX-239 MR-16 honeycomb louver, **Black**
- CX-240-AM MR-16 color lens, **Amber**
- CX-240-BL MR-16 color lens, **Blue**
- CX-240-GR MR-16 color lens, **Green**
- CX-240-RD MR-16 color lens, **Red**
- CX-240-YL MR-16 color lens, **Yellow**
- CX-241 MR-16 lens, **Linear Spread**
- CX-242 MR-16 lens, **Frosted**
- CX-243 MR-16 lens, **Prismatic**

• For MR-16 Lenses and Louvers, you will need the CX-238

